

**4.75 IN./120.65MM
 TORPEDO DIA.**

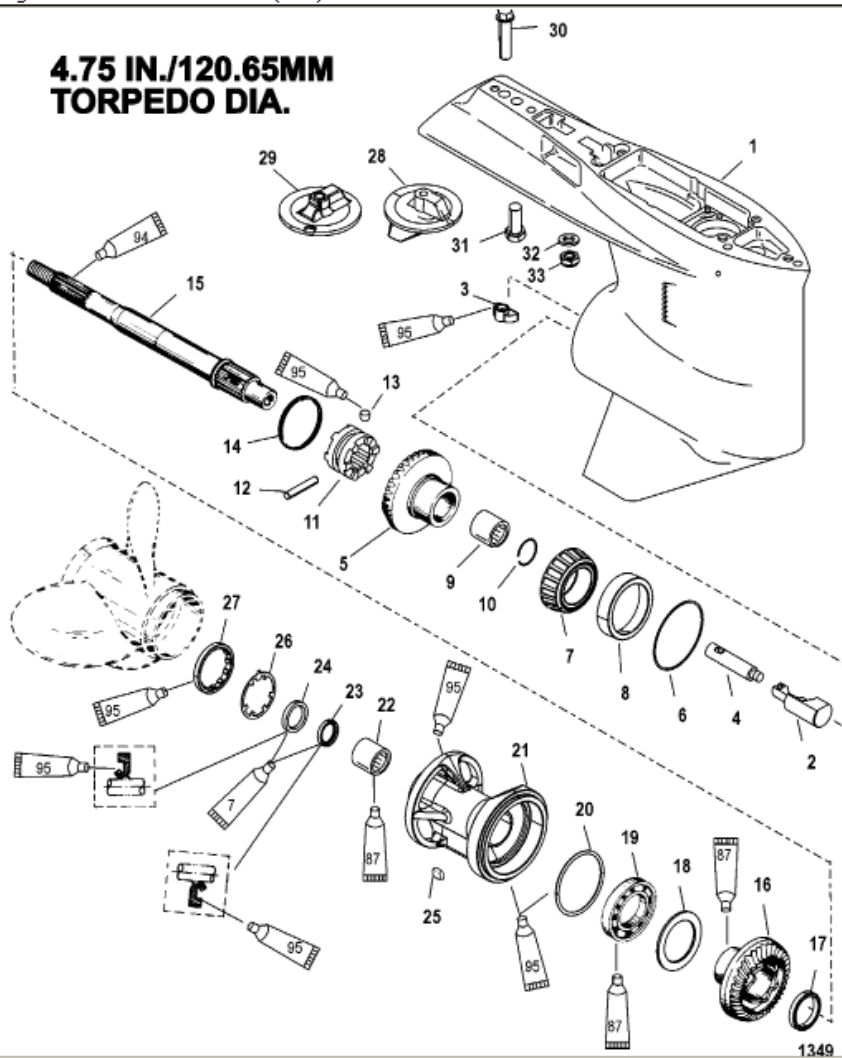

Parts List						
Ref	Class	Part	Description	Qty	Comment	Footnote
0	1647	9148T84	GEAR HOUSING ASSEMBLY, Con	1	(LONG - 1.87:1)	
0	1647	9148T85	GEAR HOUSING ASSEMBLY, Con	1	(X-LONG - 1.87:1)	
0	1647	9148T81	GEAR HOUSING ASSEMBLY, Con	1	(LONG - 2:1)	
0	1647	9148T82	GEAR HOUSING ASSEMBLY, Con	1	(X-LONG - 2:1)	
1	1647	9148T93	GEAR HOUSING, (Basic)	1		
2		89594A 1	FOLLOWER	1		24
3		78956 2	SHIFT CAM	1		24
4		828287	ROD	1		24
5	43	878613A 2	FORWARD GEAR, (1.87:1 - 15/2	1	(1.87:1 Gear Ratio) SN# 0T97999	
5	43	803615T 2	PINION/FORWARD GEAR ASSI	1	(1.87:1 Gear Ratio) SN# 0T98000	
5	43	878615A 2	FORWARD GEAR, (2:1 - 14/28)	1	(2:1 Gear Ratio) SN# 0T97999 &	
5	43	803612T 2	PINION/FORWARD GEAR ASSI	1	(2:1 Gear Ratio) SN# 0T98000 &	
6	15	44491A 1	SHIM SET	AR		23
7	31	30894A 1	BEARING SET, Cup And Cone	1		
8		NSS	NOT SOLD SEPARATE, Cup	1		
9	31	30895T	BEARING, Needle	1		23
10	53	856823	RING, Retaining	1		
11	52	859340T	CLUTCH	1		24
12	17	30632	PIN, Cross	1		24
13	17	828356	PIN, Detent	1		24
14	24	30893	SPRING	1		24
15	44	94148	PROPELLER SHAFT	1		
16	43	828175A 1	REVERSE GEAR, (15/28)	1	(1.87:1 Gear Ratio)	
16	43	828177A 1	REVERSE GEAR, (14/28)	1	(2:1 Gear Ratio)	
17	23	824108	SPACER	1		
18		68100 1	RING, Thrust	1		23
19	30	88957T	BALL BEARING	1		23
20	25	31534	O-RING	1		2,15
21		43567T 1	BEARING CARRIER ASSEMBLY	1		
22	31	30956T	BEARING, Needle	1		23
23	26	14077	SEAL, Oil (INSIDE)	1		
24	26	76868	SEAL (OUTSIDE)	1		15
25	28	30281	KEY	1		
26	14	79447	TAB WASHER	1		23
27		79448	RETAINER	1		
28		31640T 5	TRIM TAB	1		
29		76214Q 5	ANODIC PLATE ASSEMBLY	1		
30	10	806327	SCREW, (.437-14 x 1.750)	1		
31	10	65210	SCREW, (.375-16 x 1.00)	1		
32	12	45176	WASHER, (.453 x .812 x .105)	2		
33	11	24922	NUT, (.427-20)	2		